

PDC-1275

12 Volt 7.7 AH @ 20-hr. rate
7.2 AH @ 10-hr. rate

Rechargeable Sealed Lead Acid Battery
PDC SERIES AGM DEEP CYCLE



Features

- Absorbent Glass Mat (AGM) technology for superior performance
- Valve regulated, spill proof construction allows safe operation in any position
- Oversize negative plates and a specialized paste formulation provide true deep cycle performance.
- Special additives in the paste ensure superior performance in deep discharge situations.
- Power/volume ratio yielding unrivaled energy density
- Rugged impact resistant ABS case and cover (UL94-HB)
- Approved for transport by air. D.O.T., I.A.T.A., F.A.A. and C.A.B. certified
- U.L. recognized under file number MH 20845

Terminals (mm)

- F2 - Quick disconnect tabs, 0.250" x 0.032"
- Mate with AMP. INC FASTON "250" series

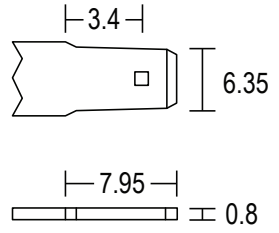

Performance Specifications

Nominal Voltage	12 volts (6 cells)
Nominal Capacity	
20-hr. (385mA to 10.50 volts)	7.70 AH
10-hr. (720mA to 10.50 volts)	7.20 AH
8-hr. (890mA to 10.50 volts)	7.10 AH
5-hr. (1.26A to 10.20 volts)	6.31 AH
1-hr. (4.65A to 9.00 volts)	4.65 AH
15-min. (14.2A to 9.00 volts).....	3.55 AH

Approximate Weight	5.51 lbs. (2.50 kg)
Energy Density (20-hr. rate)	1.52 W-h/in ³ (93.05 W-h/l)
Specific Energy (20-hr. rate)	15.68 W-h/lb (34.50 W-h/kg)
Internal Resistance (approx.)	18.0 milliohms
Max Discharge Current (7 Min.)	21.6 amperes
Max Short-Duration Discharge Current (10 Sec.).....	72 amperes
Shelf Life (% of nominal capacity at 68 °F (20 °C))	

1 Month	97%
3 Months.....	91%
6 Months	83%

Operating Temperature Range

Charge ..	-4 °F (-20 °C) to 122 °F (50 °C)
Discharge.....	-40 °F (-40 °C) to 140 °F (60 °C)

Case ABS Plastic
Power-Sonic Chargers PSC-12800A-C

Physical Dimensions: in (mm)

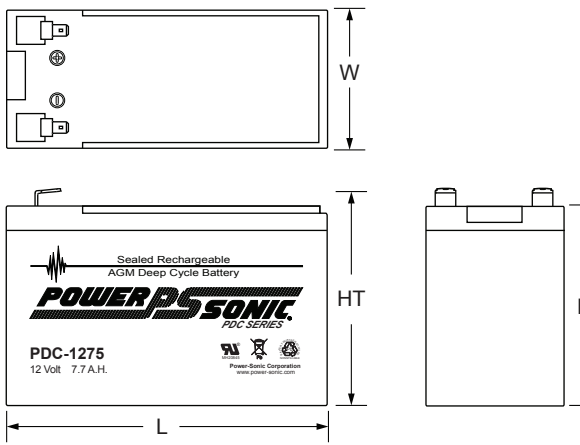

L: 5.95 (151) W: 2.56 (65) H: 3.72 (94.5) HT: 3.94 (100)

Tolerances are +/- 0.04 in. (+/- 1mm) and +/- 0.08 in. (+/- 2mm) for height dimensions. All data subject to change without notice.

Discharge Characteristics

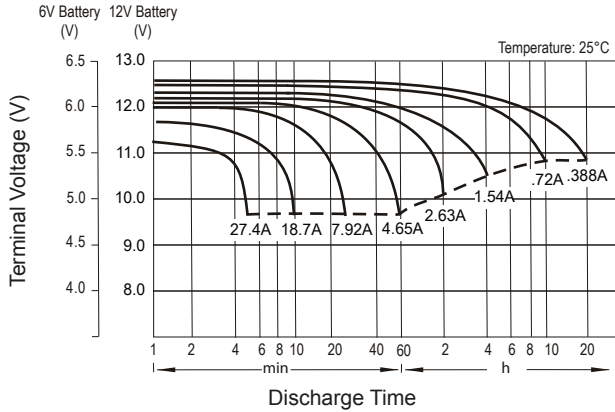

Charging Characteristics (Cycle Use)

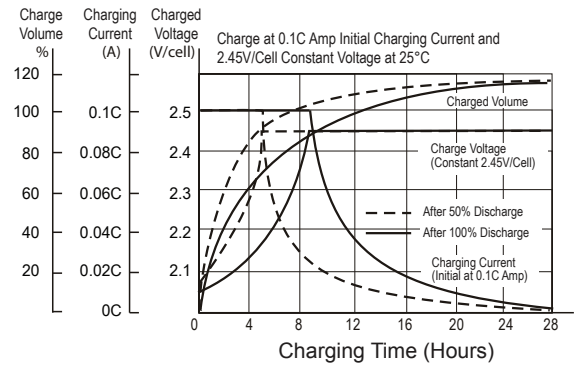

Cycle Life in Relation to Depth of Discharge

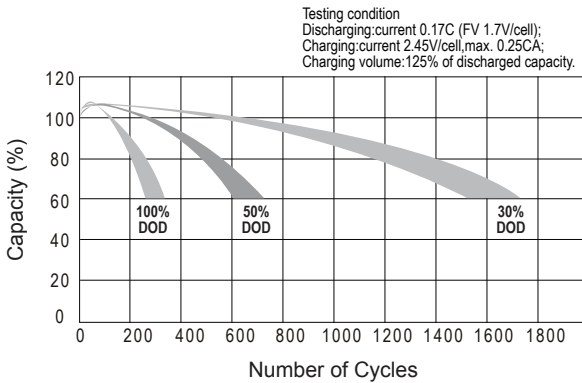

Temperature Effects in Relation to Battery Capacity

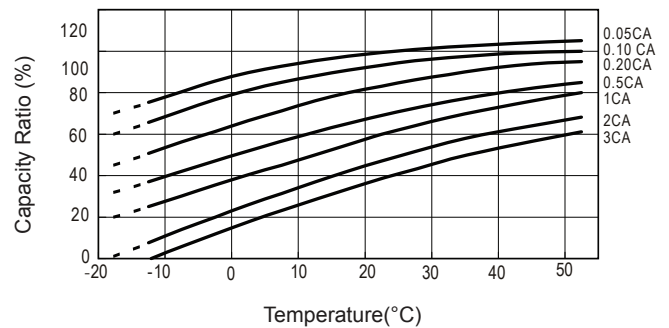

Self Discharge Characteristics

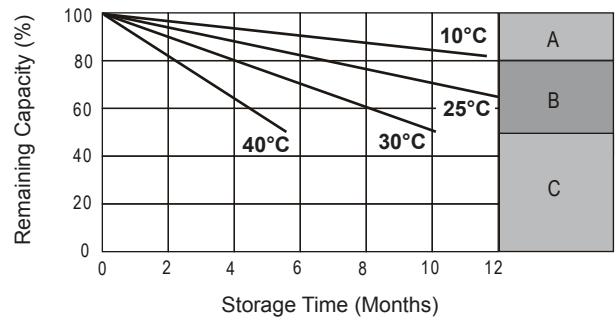

- A** No supplementary charge required
(Carry out supplementary charge before use if 100% capacity is required.)
- B** Supplementary charge required before use. Optional charging way as below:
1. Charged for above 3 days at limited current 0.25CA and constant voltage 2.25V/cell.
2. Charged for above 20 hours at limited current 0.25CA and constant voltage 2.45V/cell.
3. Charged for 8-10 hours at limited current 0.05CA.
- C** Supplementary charge may often fail to recover the capacity.
The battery should never be left standing till this is reached

Charging

Cycle Applications: Limit initial current to 2.16A. Charge until battery voltage (under charge) reaches 14.4 to 14.7 volts at 68°F (20°C). Hold at 14.4 to 14.7 volts until current drops to under 77mA. Battery is fully charged under these conditions, and charger should be disconnected or switched to “float” voltage.

“Float” or “Stand-By” Service: Hold battery across constant voltage source of 13.5 to 13.8 volts continuously. When held at this voltage, the battery will seek its own current level and maintain itself in a fully charged condition.

Note: Due to the self-discharge characteristics of this type of battery, it is imperative that they be charged within 6 months of storage, otherwise permanent loss of capacity might occur as a result of sulfation.

Chargers

Power-Sonic offers a wide range of chargers suitable for batteries up to 100AH. Please refer to the Charger Selection Guide in our specification sheets for “C-Series Switch Mode Chargers” and “Transformer Type A and F Series”. Please contact our Technical department for advice if you have difficulty in locating suitable models.

Further Information

Please refer to our website www.power-sonic.com for a complete range of useful downloads, such as product catalogs, material safety data sheets (MSDS), ISO certification, etc..

Contact Information

www.power-sonic.com

DOMESTIC SALES

Tel: +1-619-661-2020
Fax: +1-619-661-3650
national-sales@power-sonic.com

CUSTOMER SERVICE

Tel: +1-619-661-2030
Fax: +1-619-661-3648
customer-service@power-sonic.com

TECHNICAL SUPPORT

Tel: +1-619-661-2020
Fax: +1-619-661-3648
support@power-sonic.com

INTERNATIONAL SALES

Tel: +1-650-364-5001
Fax: +1-650-366-3662
battery@power-sonic.com